

MODEL LFS150A-5

雑音端子電圧 Conducted Emission

Conditions

Vin: 100VAC / 50Hz
 Iout: 100%
 Limit(QP): — VCCI ClassB
 Limit(AV): — VCCI ClassB

QP Data List

Point	Freq. [Hz]	Limit [dBuV/m]	Margin [dB]
A	192.9k	63.9	18.6
B	260.6k	61.4	15.5
C	2.59M	56.0	18.0
D	260.9k	61.4	15.4
E	521.1k	56.0	19.2
F	2.59M	56.0	18.8

AV Data List

Point	Freq. [Hz]	Limit [dBuV/m]	Margin [dB]
A	192.9k	53.9	11.8
B	260.6k	51.4	7.7
C	2.59M	46.0	23.8
D	260.9k	51.4	7.9
E	521.1k	46.0	14.4
F	2.59M	46.0	23.8

Phase: N

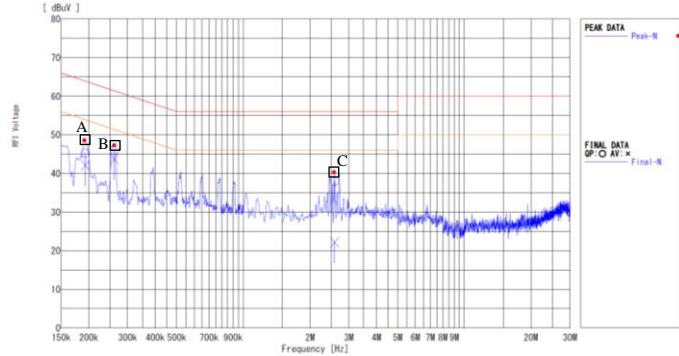

Phase: L

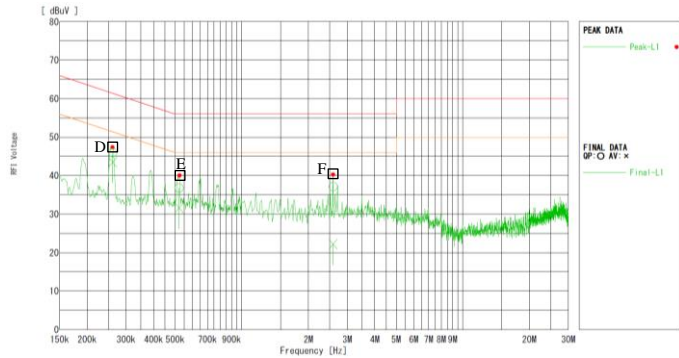

Conditions

Vin: 230VAC / 50Hz
 Iout: 100%
 Limit(QP): — EN55022 ClassB
 Limit(AV): — VCCI ClassB

QP Data List

Point	Freq. [Hz]	Limit [dBuV/m]	Margin [dB]
A	150.9k	66.0	16.5
B	193.4k	63.9	18.4
C	257.2k	61.5	15.9
D	260.2k	61.4	15.4
E	2.97M	56.0	20.1

AV Data List

Point	Freq. [Hz]	Limit [dBuV/m]	Margin [dB]
A	150.9k	56.0	24.0
B	193.4k	53.9	12.7
C	257.2k	51.5	9.4
D	260.2k	51.4	8.2
E	2.97M	46.0	25.1

Phase: N

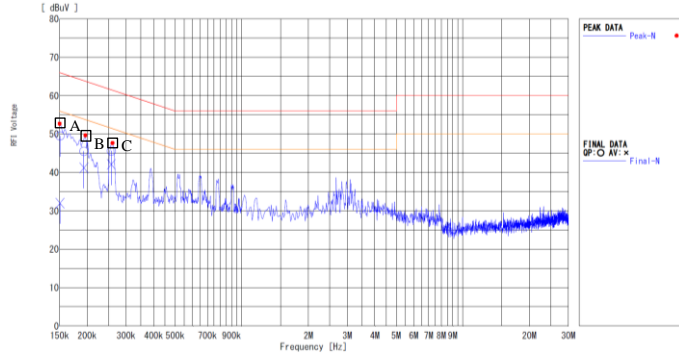

Phase: L

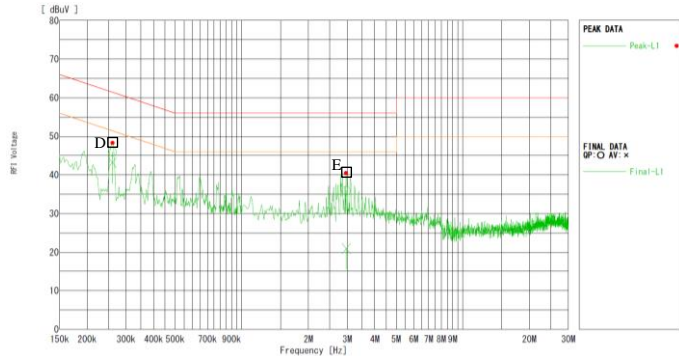

MODEL LFS150A-12

雑音端子電圧 Conducted Emission

Conditions

Vin: 100VAC / 50Hz
 Iout: 100%
 Limit(QP): — VCCI ClassB
 Limit(AV): — VCCI ClassB

QP Data List

Point	Freq. [Hz]	Limit [dBuV/m]	Margin [dB]
A	150.1k	66.0	18.2
B	251.1k	61.7	21.0
C	249.4k	61.8	21.6

Phase: N

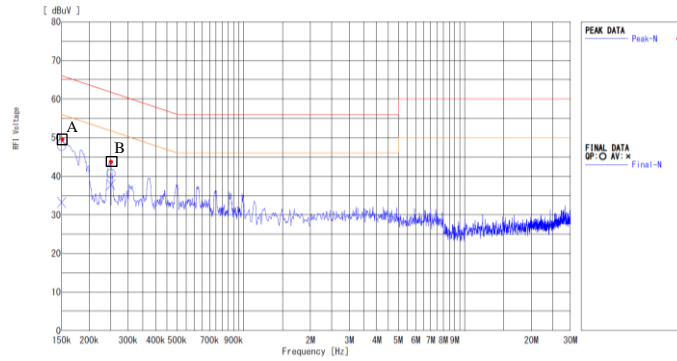

Phase: L

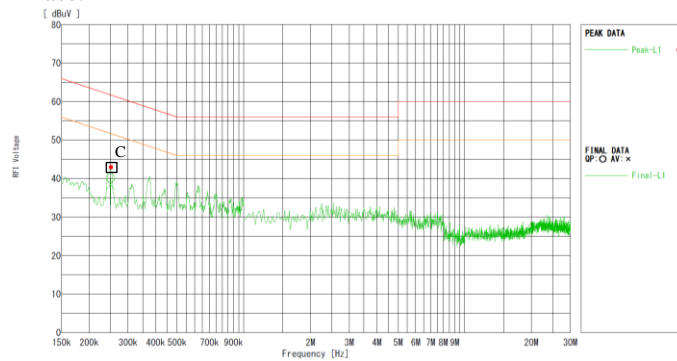

AV Data List

Point	Freq. [Hz]	Limit [dBuV/m]	Margin [dB]
A	150.1k	56.0	22.8
B	251.1k	51.7	13.9
C	249.4k	51.8	13.3

Conditions

Vin: 230VAC / 50Hz
 Iout: 100%
 Limit(QP): — EN55022 ClassB
 Limit(AV): — VCCI ClassB

QP Data List

Point	Freq. [Hz]	Limit [dBuV/m]	Margin [dB]
A	150.7k	66.0	17.1
B	186.6k	64.2	18.4
C	2.91M	56.0	18.6
D	499.2k	56.0	20.9
E	3.08M	56.0	20.2

Phase: N

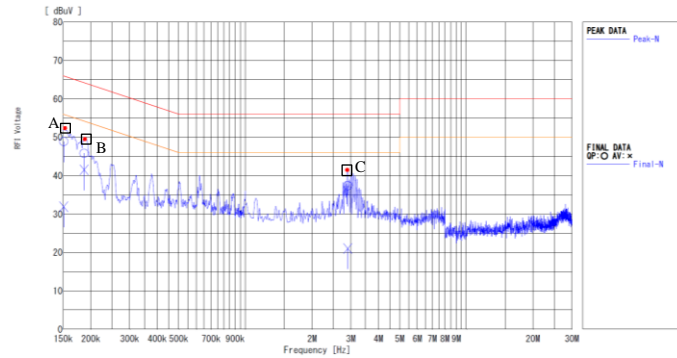

Phase: L

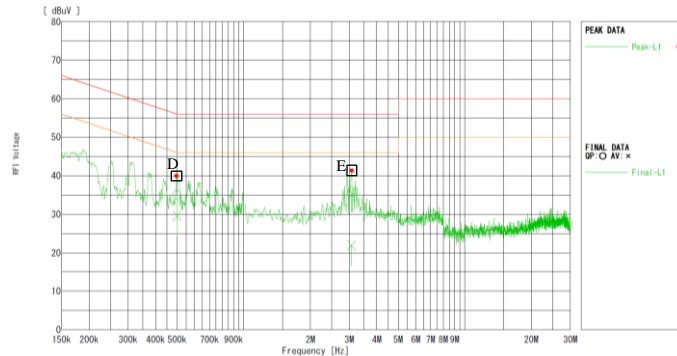

AV Data List

Point	Freq. [Hz]	Limit [dBuV/m]	Margin [dB]
A	150.7k	56.0	24.1
B	186.6k	54.2	12.7
C	2.91M	46.0	25.0
D	499.2k	46.0	16.4
E	3.08M	46.0	24.1

MODEL | LFS150A-15

雑音端子電圧 Conducted Emission

Conditions

Vin: 100VAC / 50Hz
 Iout: 100%
 Limit(QP): — VCCI ClassB
 Limit(AV): — VCCI ClassB

QP Data List

Point	Freq. [Hz]	Limit [dBuV/m]	Margin [dB]
A	150.3k	66.0	16.7
B	186.3k	64.2	20.5
C	187.0k	64.2	19.9

AV Data List

Point	Freq. [Hz]	Limit [dBuV/m]	Margin [dB]
A	150.3k	56.0	21.5
B	186.3k	54.2	15.0
C	187.0k	54.2	13.2

Phase: N

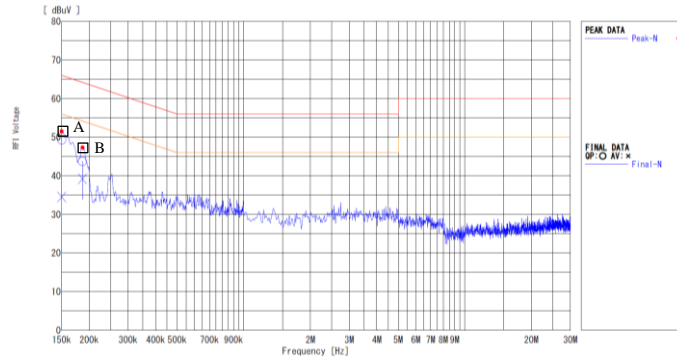

Phase: L

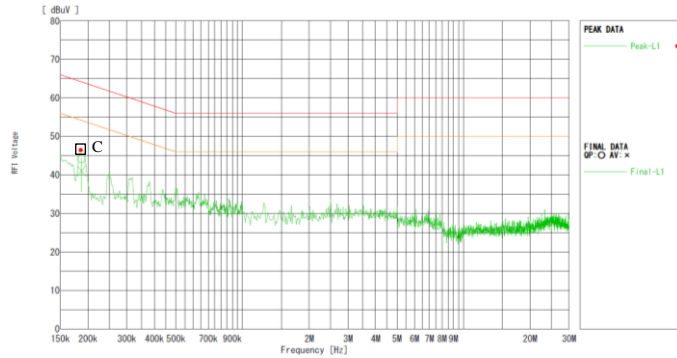

Conditions

Vin: 230VAC / 50Hz
 Iout: 100%
 Limit(QP): — EN55022 ClassB
 Limit(AV): — VCCI ClassB

QP Data List

Point	Freq. [Hz]	Limit [dBuV/m]	Margin [dB]
A	150.9k	65.9	16.1
B	3.15M	56.0	21.1
C	310.0k	60.0	22.8
E	3.16M	56.0	20.5

AV Data List

Point	Freq. [Hz]	Limit [dBuV/m]	Margin [dB]
A	150.9k	55.9	23.5
B	3.15M	46.0	25.6
C	310.0k	50.0	17.1
E	3.16M	46.0	25.4

Phase: N

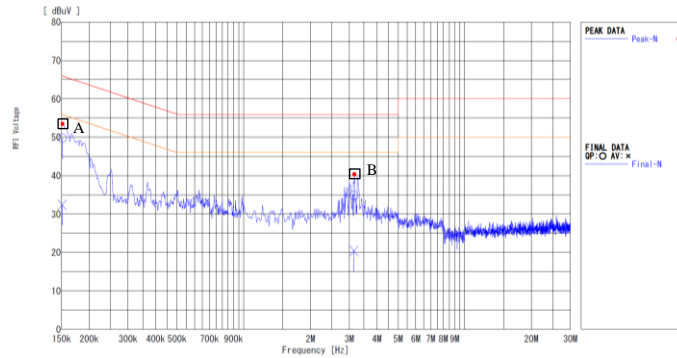

Phase: L

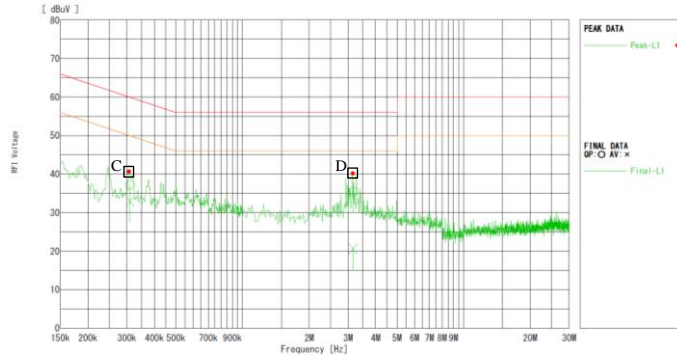

MODEL LFS150A-24

雑音端子電圧 Conducted Emission

Conditions

Vin: 100VAC / 50Hz
 Iout: 100%
 Limit(QP): — VCCI ClassB
 Limit(AV): — VCCI ClassB

QP Data List

Point	Freq. [Hz]	Limit [dBuV/m]	Margin [dB]
A	150.6	66.0	18.3
B	189.6	64.1	18.9

AV Data List

Point	Freq. [Hz]	Limit [dBuV/m]	Margin [dB]
A	150.6	56.0	22.7
B	189.6	54.1	12.9

Phase: N

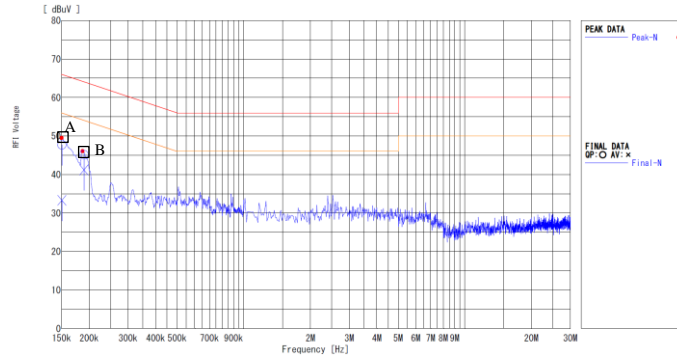

Phase: L

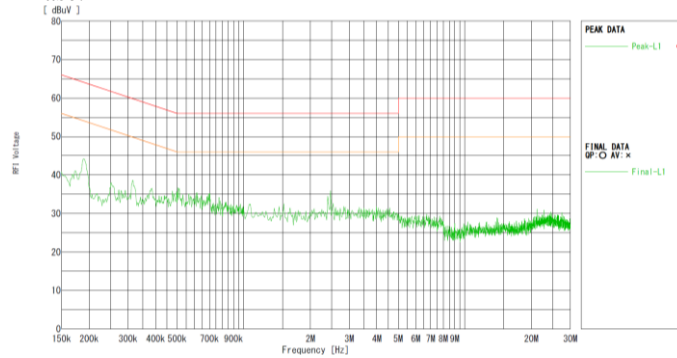

Conditions

Vin: 230VAC / 50Hz
 Iout: 100%
 Limit(QP): — EN55022 ClassB
 Limit(AV): — VCCI ClassB

QP Data List

Point	Freq. [Hz]	Limit [dBuV/m]	Margin [dB]
A	155.5k	65.7	17.6
B	194.8k	63.8	18.6
C	2.96M	56.0	18.5
D	194.5k	63.8	18.2
E	317.0k	59.8	19.1
F	2.96M	56.0	18.3

AV Data List

Point	Freq. [Hz]	Limit [dBuV/m]	Margin [dB]
A	155.5k	55.7	23.9
B	194.8k	53.8	13.2
C	2.96M	46.0	24.3
D	194.5k	53.8	11.1
E	317.0k	49.8	16.9
F	2.96M	46.0	23.9

Phase: N

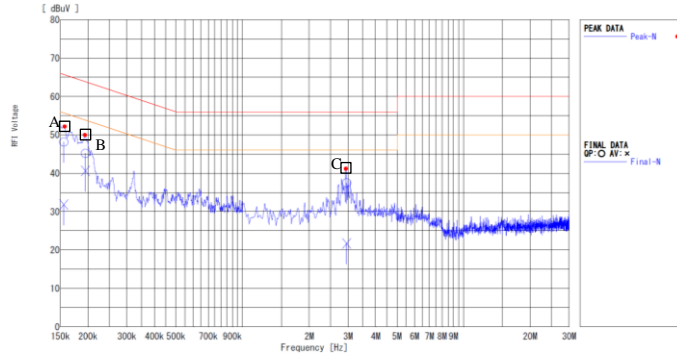

Phase: L

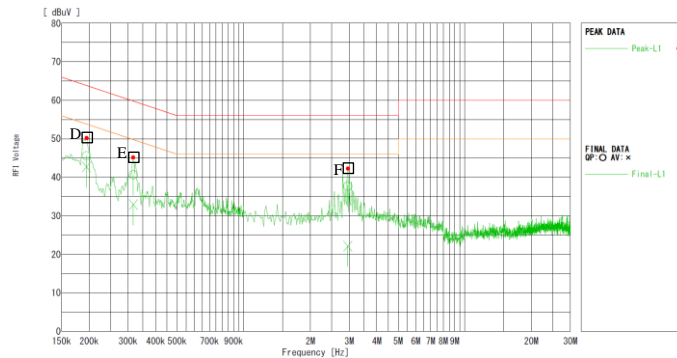

MODEL LFS150A-30

雑音端子電圧 Conducted Emission

Conditions

Vin: 100VAC / 50Hz
 Iout: 100%
 Limit(QP): — VCCI ClassB
 Limit(AV): — VCCI ClassB

QP Data List

Point	Freq. [Hz]	Limit [dBuV/m]	Margin [dB]
A	151.5k	65.9	14.7
B	226.6k	62.6	18.4

AV Data List

Point	Freq. [Hz]	Limit [dBuV/m]	Margin [dB]
A	151.5k	55.9	9.8
B	226.6k	52.6	9.6

Phase: N

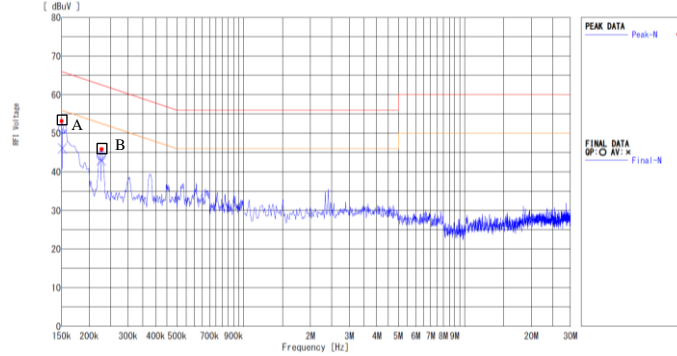

Phase: L

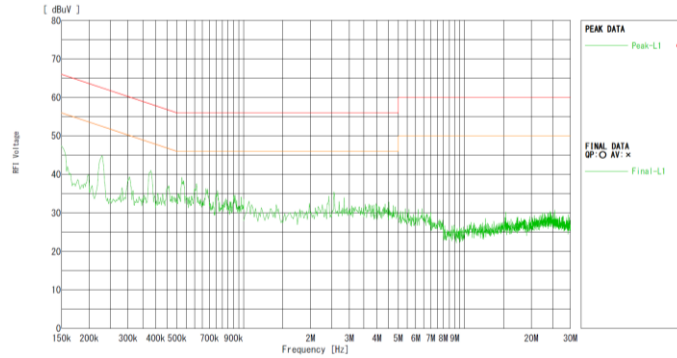

Conditions

Vin: 230VAC / 50Hz
 Iout: 100%
 Limit(QP): — EN55022 ClassB
 Limit(AV): — VCCI ClassB

QP Data List

Point	Freq. [Hz]	Limit [dBuV/m]	Margin [dB]
A	150.6k	66.0	8.8
B	225.8k	62.6	17.1
C	3.06M	56.0	15.4
D	155.2k	65.7	17.8
E	901.0k	56.0	20.3
F	3.13M	56.0	15.8

AV Data List

Point	Freq. [Hz]	Limit [dBuV/m]	Margin [dB]
A	150.6k	56.0	12.4
B	225.8k	52.6	15.8
C	3.06M	46.0	25.3
D	155.2k	55.7	18.0
E	901.0k	46.0	26.4
F	3.13M	46.0	24.2

Phase: N

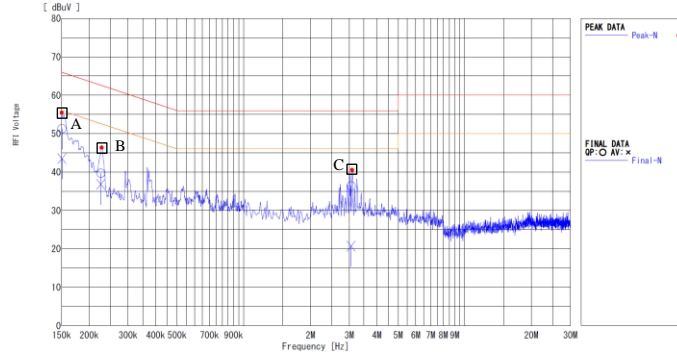

Phase: L

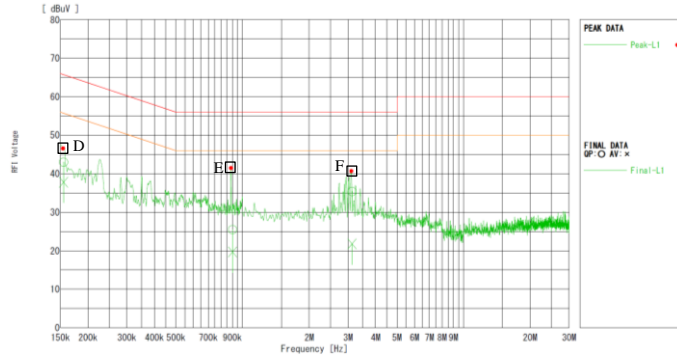

MODEL | LFS150A-48

雑音端子電圧 Conducted Emission

Conditions

Vin: 100VAC / 50Hz
 Iout: 100%
 Limit(QP): — VCCI ClassB
 Limit(AV): — VCCI ClassB

QP Data List

Point	Freq. [Hz]	Limit [dBuV/m]	Margin [dB]
A	150.4k	66.0	18.0
B	200.3k	63.6	20.9
C	304.9k	60.1	18.7

AV Data List

Point	Freq. [Hz]	Limit [dBuV/m]	Margin [dB]
A	150.4k	56.0	21.8
B	200.3k	53.6	12.8
C	304.9k	50.1	11.7

Phase: N

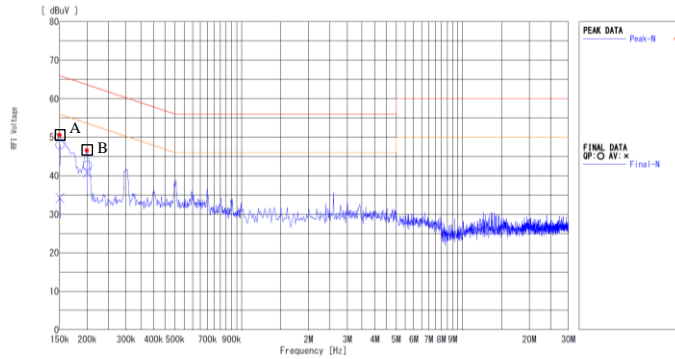

Phase: L

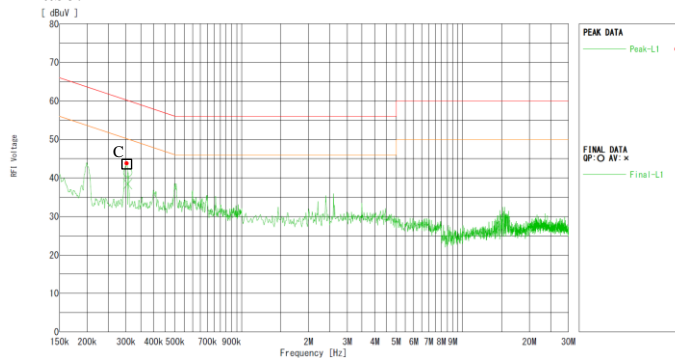

Conditions

Vin: 230VAC / 50Hz
 Iout: 100%
 Limit(QP): — EN55022 ClassB
 Limit(AV): — VCCI ClassB

QP Data List

Point	Freq. [Hz]	Limit [dBuV/m]	Margin [dB]
A	150.1k	66.0	12.1
B	203.6k	63.5	14.5
C	3.03M	56.0	15.4

AV Data List

Point	Freq. [Hz]	Limit [dBuV/m]	Margin [dB]
A	150.1k	56.0	23.7
B	203.6k	53.5	16.7
C	3.03M	46.0	24.6

Phase: N

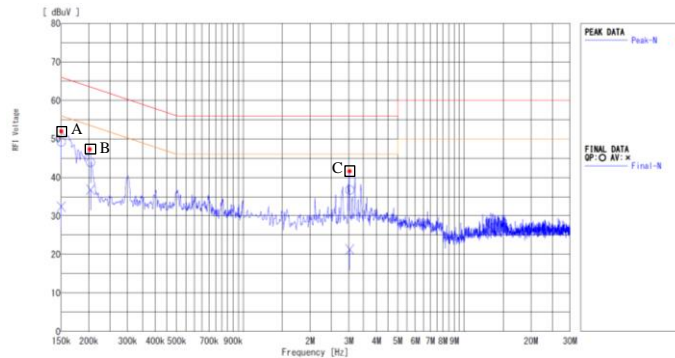

Phase: L

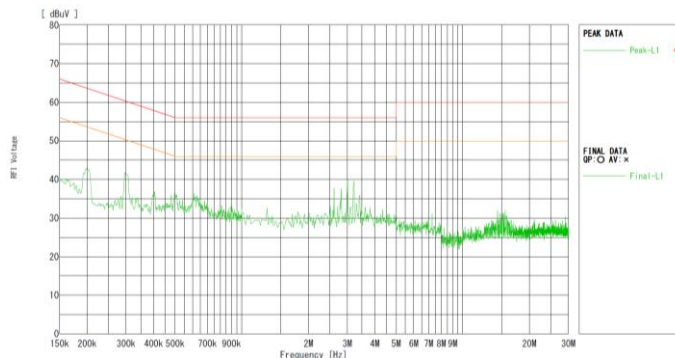

MODEL LFS150A-5

雑音電界強度 Radiated Emission

Conditions

Vin: 100VAC / 50Hz
 Iout: 100%
 Limit(QP): — VCCI ClassB

QP Data List

Point	Freq. [Hz]	Limit [dBuV/m]	Margin [dB]
A	123.1M	40.0	14.1
B	141.3M	40.0	10.5

■ 水平 HORIZONTAL

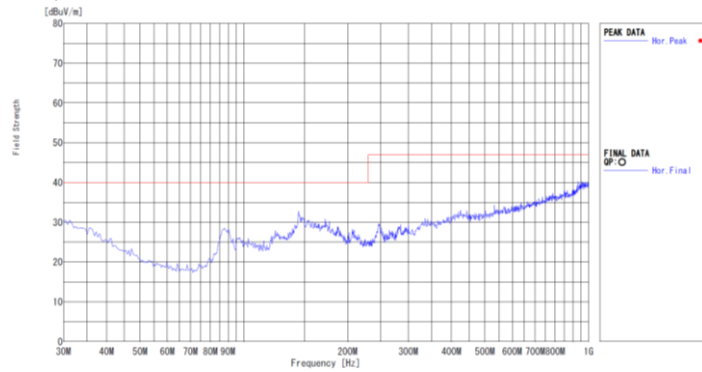

■ 垂直 VERTICAL

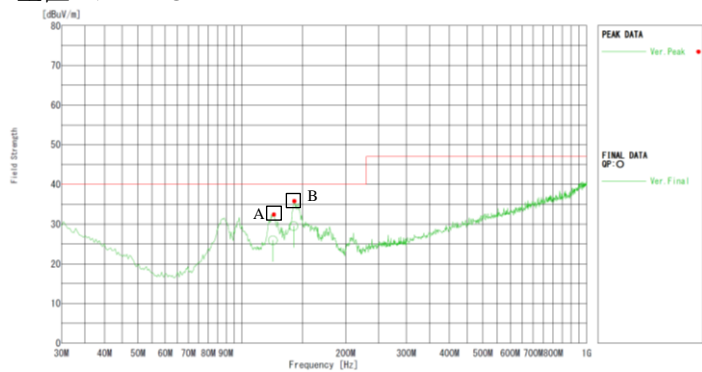

Conditions

Vin: 230VAC / 50Hz
 Iout: 100%
 Limit(QP): — EN55022 ClassB

QP Data List

Point	Freq. [Hz]	Limit [dBuV/m]	Margin [dB]
A	88.3M	40.0	15.0
B	124.3M	40.0	13.3

■ 水平 HORIZONTAL

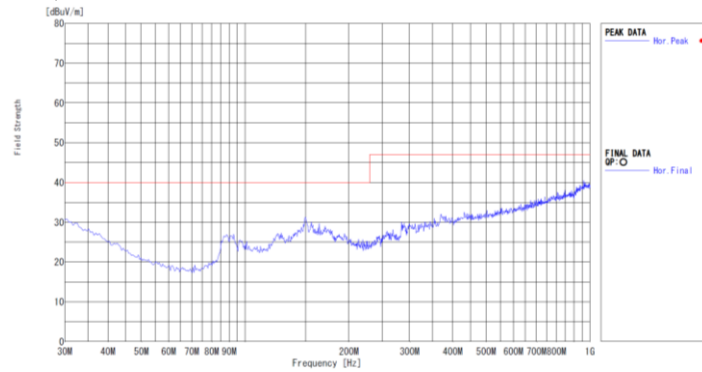

■ 垂直 VERTICAL

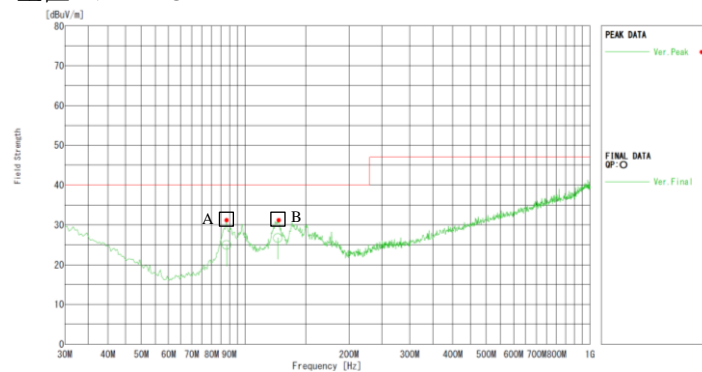

MODEL | LFS150A-12

雑音電界強度 Radiated Emission

Conditions

Vin: 100VAC / 50Hz
 Iout: 100%
 Limit(QP): — VCCI ClassB

QP Data List

Point	Freq. [Hz]	Limit [dBuV/m]	Margin [dB]
A	208.6M	40.0	13.1
B	86.9M	40.0	12.7
C	140.0M	40.0	13.7
D	975.0M	40.0	12.1

■ 水平 HORIZONTAL

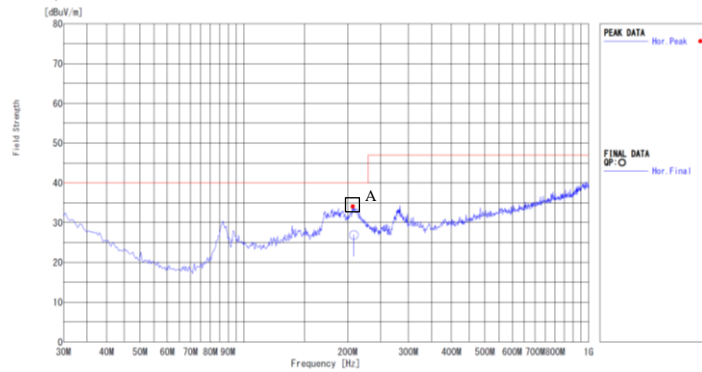

■ 垂直 VERTICAL

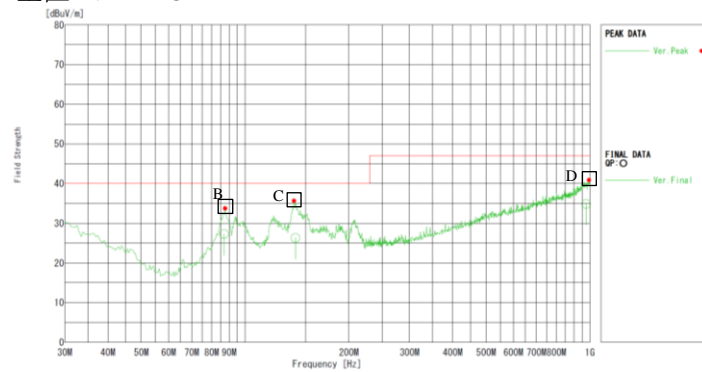

Conditions

Vin: 230VAC / 50Hz
 Iout: 100%
 Limit(QP): — EN55022 ClassB

QP Data List

Point	Freq. [Hz]	Limit [dBuV/m]	Margin [dB]
A	87.4M	40.0	12.8
B	139.1M	40.0	12.9

■ 水平 HORIZONTAL

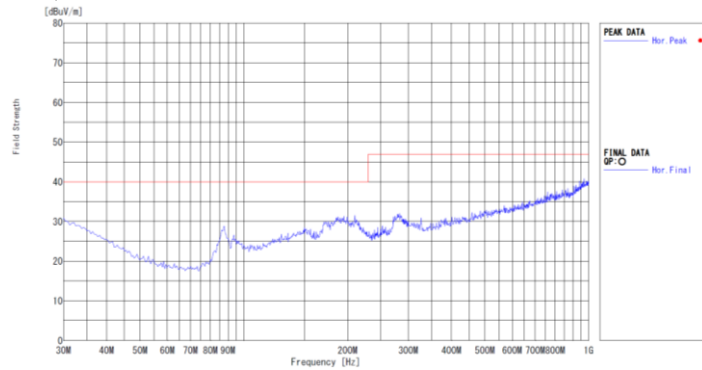

■ 垂直 VERTICAL

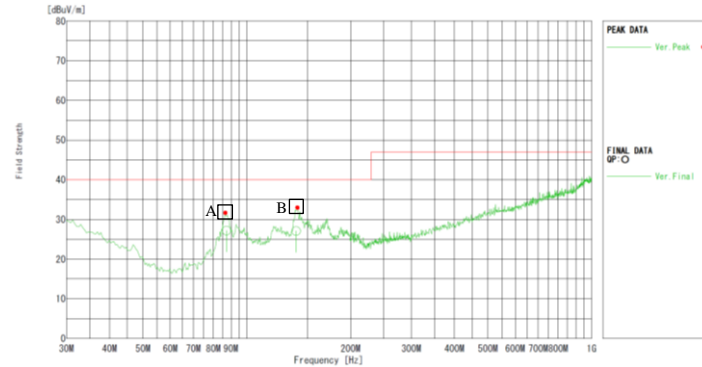

MODEL | LFS150A-15

雑音電界強度 Radiated Emission

Conditions

Vin: 100VAC / 50Hz
Iout: 100%
Limit(QP): — VCCI ClassB

QP Data List

Point	Freq. [Hz]	Limit [dBuV/m]	Margin [dB]
A	189.0M	40.0	7.4
B	124.3M	40.0	14.6
C	139.3M	40.0	12.7
D	174.4M	40.0	16.5

■ 水平 HORIZONTAL

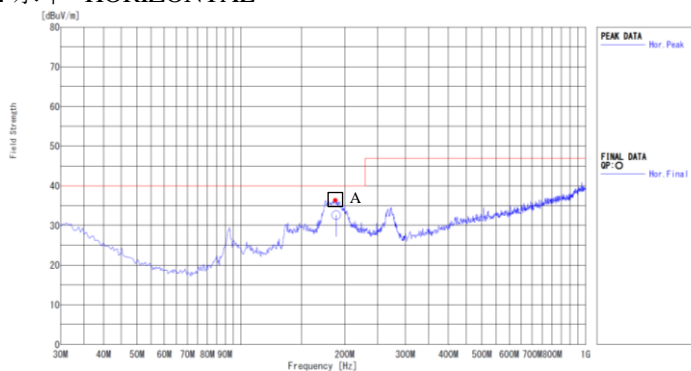

■ 垂直 VERTICAL

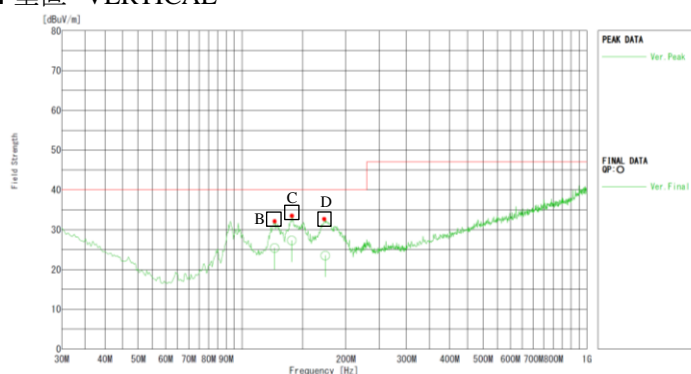

Conditions

Vin: 230VAC / 50Hz
Iout: 100%
Limit(QP): — EN55022 ClassB

QP Data List

Point	Freq. [Hz]	Limit [dBuV/m]	Margin [dB]
A	176.0M	40.0	7.1
B	188.4M	40.0	9.6
C	174.0M	40.0	13.4
D	189.0M	40.0	17.9

■ 水平 HORIZONTAL

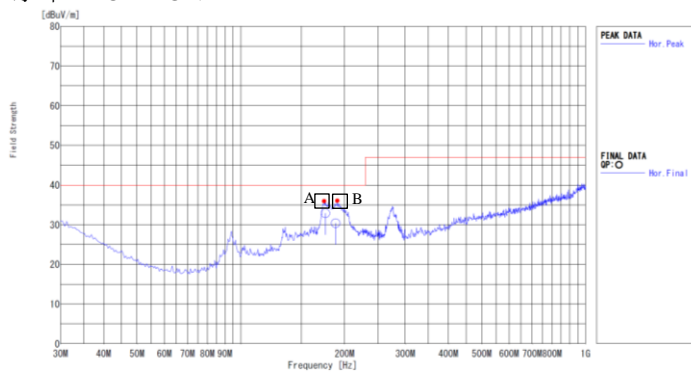

■ 垂直 VERTICAL

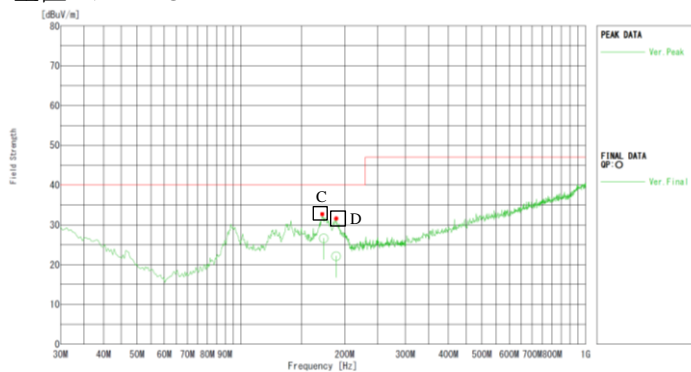

MODEL | LFS150A-24

雑音電界強度 Radiated Emission

Conditions

Vin: 100VAC / 50Hz
 Iout: 100%
 Limit(QP): — VCCI ClassB

QP Data List

Point	Freq. [Hz]	Limit [dBuV/m]	Margin [dB]
A	192.7M	40.0	13.2
B	123.5M	40.0	14.3

■ 水平 HORIZONTAL

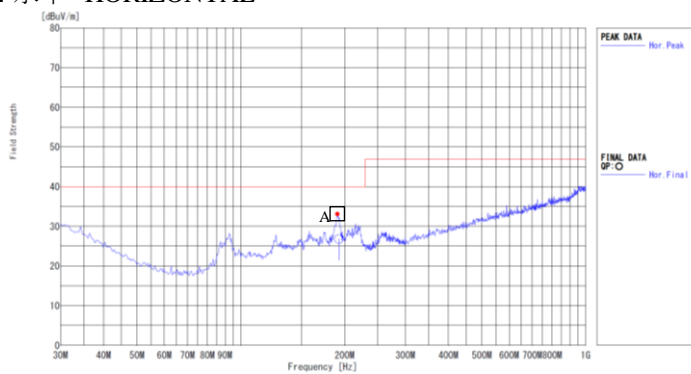

■ 垂直 VERTICAL

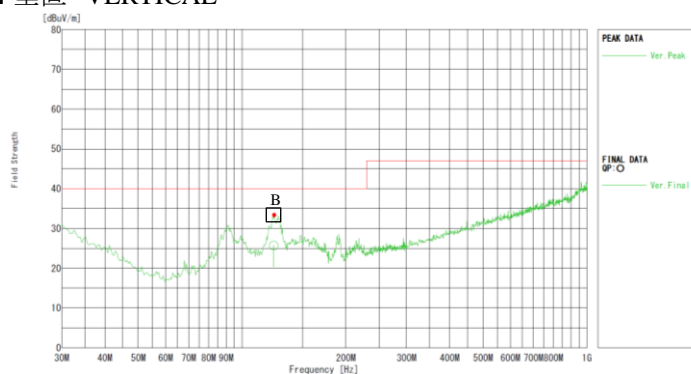

Conditions

Vin: 230VAC / 50Hz
 Iout: 100%
 Limit(QP): — EN55022 ClassB

QP Data List

Point	Freq. [Hz]	Limit [dBuV/m]	Margin [dB]
A	172.1M	40.0	13.4
B	124.5M	40.0	18.5

■ 水平 HORIZONTAL

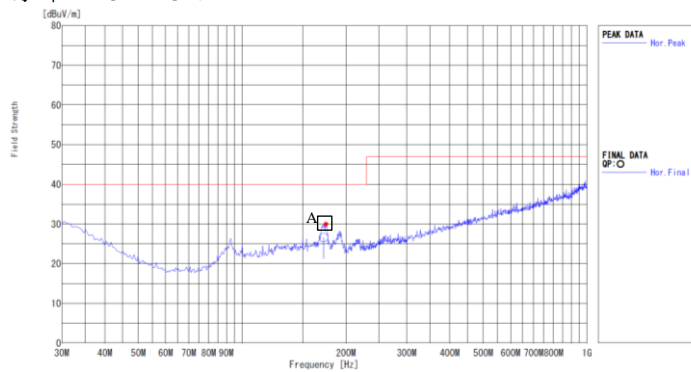

■ 垂直 VERTICAL

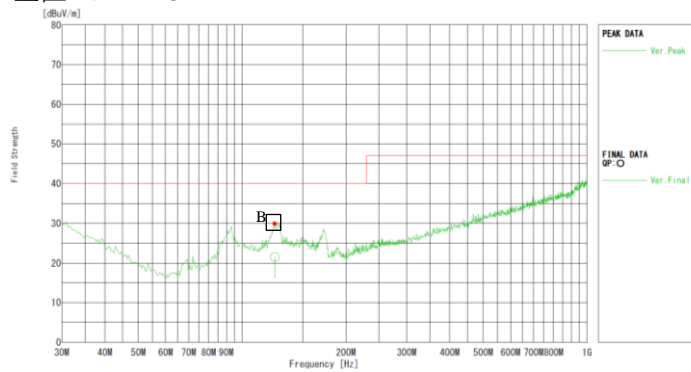

MODEL | LFS150A-30

雑音電界強度 Radiated Emission

Conditions

Vin: 100VAC / 50Hz
Iout: 100%
Limit(QP): — VCCI ClassB

QP Data List

Point	Freq. [Hz]	Limit [dBuV/m]	Margin [dB]
A	93.7M		
B	192.3M		
C	216.8M		
D	92.9M		
E	97.1M		
F	157.4M		

■ 水平 HORIZONTAL

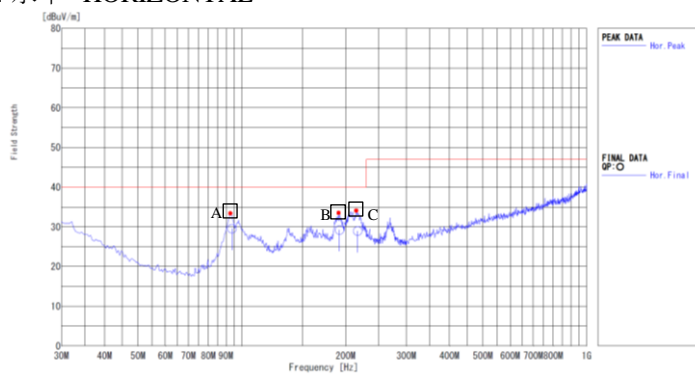

■ 垂直 VERTICAL

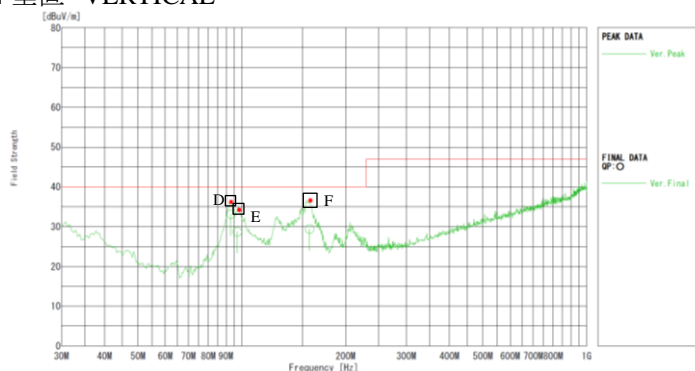

Conditions

Vin: 230VAC / 50Hz
Iout: 100%
Limit(QP): — EN55022 ClassB

QP Data List

Point	Freq. [Hz]	Limit [dBuV/m]	Margin [dB]
A	93.2M	40.0	10.2
B	93.0M	40.0	9.0
C	157.0M	40.0	10.5

■ 水平 HORIZONTAL

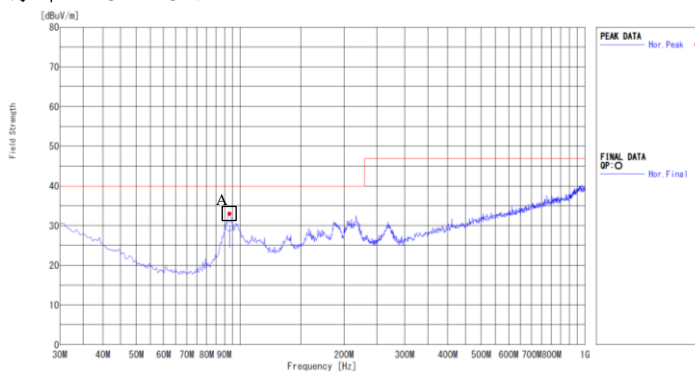

■ 垂直 VERTICAL

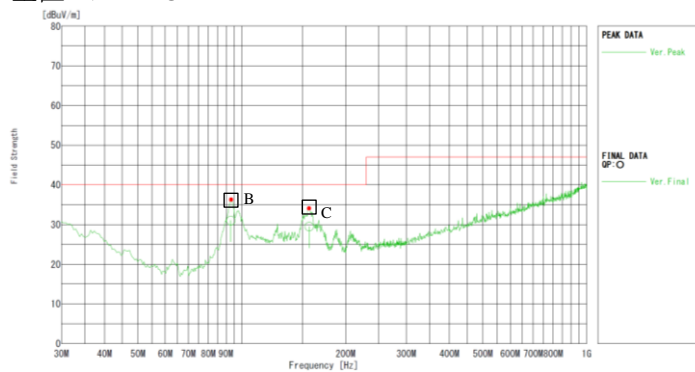

MODEL | LFS150A-48

雑音電界強度 Radiated Emission

Conditions

Vin: 100VAC / 50Hz
Iout: 100%
Limit(QP): — VCCI ClassB

QP Data List

Point	Freq. [Hz]	Limit [dBuV/m]	Margin [dB]
A	90.7M	40.0	13.5
B	214.3M	40.0	11.1
C	90.3M	40.0	10.6
D	126.0M	40.0	14.8
E	160.4M	40.0	11.3

■ 水平 HORIZONTAL

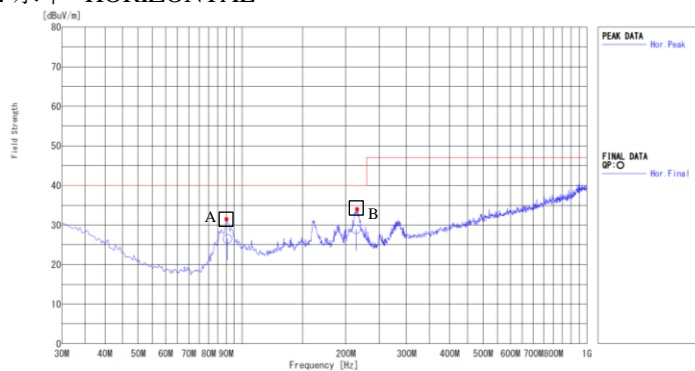

■ 垂直 VERTICAL

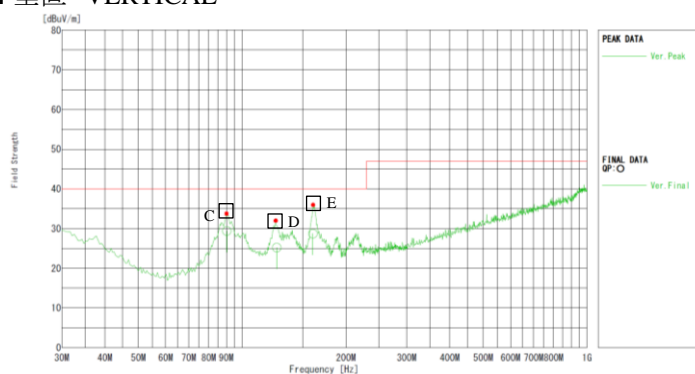

Conditions

Vin: 230VAC / 50Hz
Iout: 100%
Limit(QP): — EN55022 ClassB

QP Data List

Point	Freq. [Hz]	Limit [dBuV/m]	Margin [dB]
A	90.6M	40.0	12.9
B	216.6M	40.0	15.1
C	90.6M	40.0	11.6
D	163.3M	40.0	15.8

■ 水平 HORIZONTAL

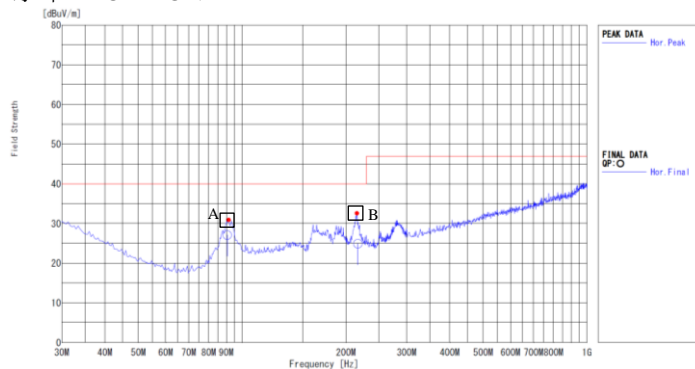

■ 垂直 VERTICAL

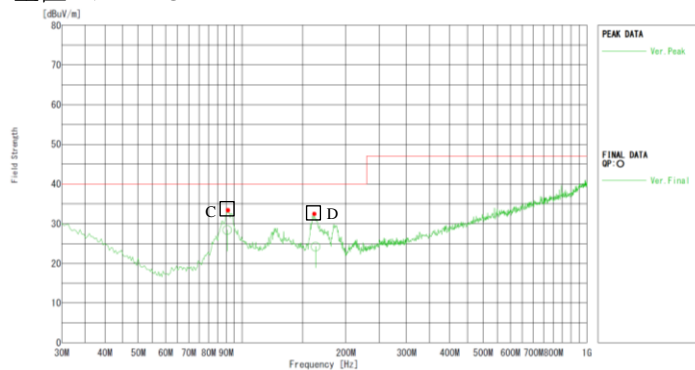

MODEL LFS150A

静電気放電イミュニティ試験 Electrostatic Discharge Immunity Test(EN61000-4-2)

1.使用試験装置 Equipment used

- ・静電気試験器 Electrostatic discharge simulator
- ・放電ガン Discharge gun
- ・静電容量 Capacity : 150pF
- ・放電抵抗 Discharge Resistance : 330Ω

2.試験条件 Test conditions

- ・カバー付き with Cover
- ・周囲温度 Ambient temperature : 25 °C
- ・入力電圧 Input voltage : 100, 230 VAC
- ・出力電圧 Output voltage : 定格 Rated
- ・出力電流 Output current : 100 %
- ・試験回数 Number of tests : 10回 10 times
- ・極性 Polarity : +, -
- ・放電間隔 Discharge interval : > 1 s

3.試験方法及び印加箇所 Test method and Device test points

- ・接触放電 Contact discharge : シャーシ, カバー, ネジ取り付け部
- ・気中放電 Air discharge : シャーシ, カバー

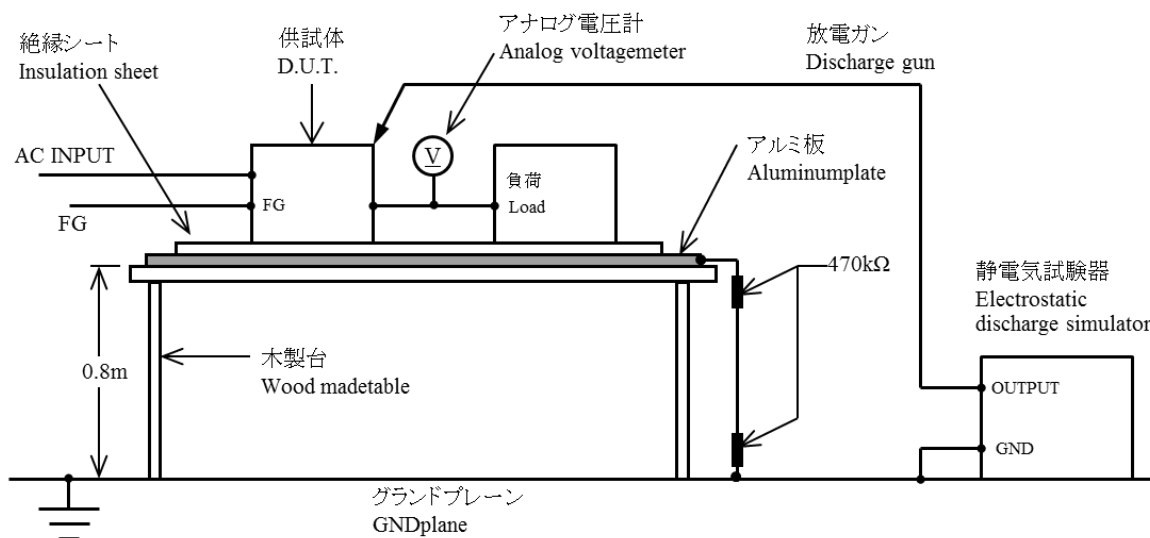

4.判定条件 Acceptable conditions

- ・試験中の出力電圧変動は、初期値(試験前)の±5%を超えないこと。
Output voltage regulation must not exceed ±5% of initial (before test) value during test.
- ・試験後の出力電圧は、初期値(試験前)から仕様範囲内の変動であること。
Output voltage after test shall be stable at the initial (before test) value (within specification range).
- ・試験中、発煙/発火及び出力低下が無いこと。
No discharge of fire or smoke, as well as no output failure during test.

5.試験結果 Test result

・接触放電 Contact discharge

LEVEL	Contact discharge (kV)	Result
1	2	OK
2	4	OK
3	6	OK
4	8	OK

・気中放電 Air discharge

LEVEL	Airt discharge (kV)	Result
1	2	OK
2	4	OK
3	8	OK
4	15	OK

MODEL LFS150A

放射無線周波数電磁界イミュニティ試験

Radiated Radio-Frequency Electromagnetic Field Immunity Test(EN61000-4-3)

1.使用試験装置 Equipment used

- 放射イミュニティ測定システム Radiation immunity measurement system
- アンテナ Antenna
 - バイログアンテナ Bilog antenna
 - スタックド・ダブルログペリアンテナ Stacked Microwave Log-Per. Antenna

2.試験条件 Test conditions

- カバー付き with Cover
- 周囲温度 Ambient temperature : 25 °C
- 入力電圧 Input voltage : 100, 230 VAC
- 出力電圧 Output voltage : 定格 Rated
- 出力電流 Output current : 100 %
- 距離 Distance : 2.1 m
- スイープ・コンディション Sweep condition : 1.0 %ステップ, 1.0 秒保持 1.0 %step up, 1.0 s hold
- 試験方向 Test angle : 上下, 左右, 前後 Top/Bottom, Both Sides, Front/Back
- 電磁界周波数 Electromagnetic frequency : 80 MHz~2.7 GHz
- 振幅変調 Amplitude modulated : 80 %, 1 kHz
- 偏波 Wave angle : 水平, 垂直 Horizontal, Vertical

3.試験方法 Test method

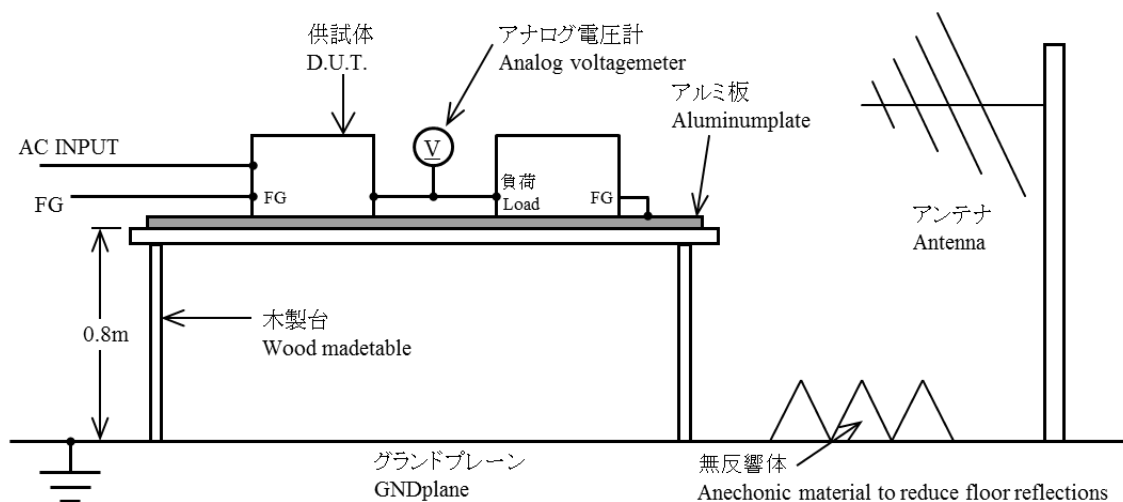

4.判定条件 Acceptable conditions

- 試験中の出力電圧変動は、初期値(試験前)の±5%を超えないこと。
Output voltage regulation must not exceed ±5% of initial (before test) value during test.
- 試験後の出力電圧は、初期値(試験前)から仕様範囲内の変動であること。
Output voltage after test shall be stable at the initial (before test) value (within specification range).
- 試験中、発煙/発火及び出力低下が無いこと。
No discharge of fire or smoke, as well as no output failure during test.

5.試験結果 Test result

LEVEL	Radiation Field Strength(V/m)	Result
1	1	OK
2	3	OK
3	10	OK

MODEL | LFS150A

電氣的ファーストランジェントバーストイミュニティ試験 Electrical Fast Transient / Burst Immunity Test(EN61000-4-4)

1.使用試験装置 Equipment used

- ・EFT/B発生器 EFT/B generator

2.試験条件 Test conditions

- ・カバー付き with Cover
- ・周囲温度 Ambient temperature : 25 °C
- ・入力電圧 Input voltage : 100, 230 VAC
- ・出力電圧 Output voltage : 定格 Rated
- ・出力電流 Output current : 100 %
- ・パルス周波数 Pulse Frequency : 5kHz, 100kHz
- ・バースト期間 Burst Time : 15ms, 0.75ms
- ・バースト周期 Burst Cycle : 300ms
- ・極性 Polarity : +, -
- ・試験時間 Test time : 1 min.
- ・試験回数 Number of tests : 3回 3 times

3.試験方法及び印加箇所 Test method and Device test points

全線(L, N, FG)に印加

Apply to All lines(L, N, FG).

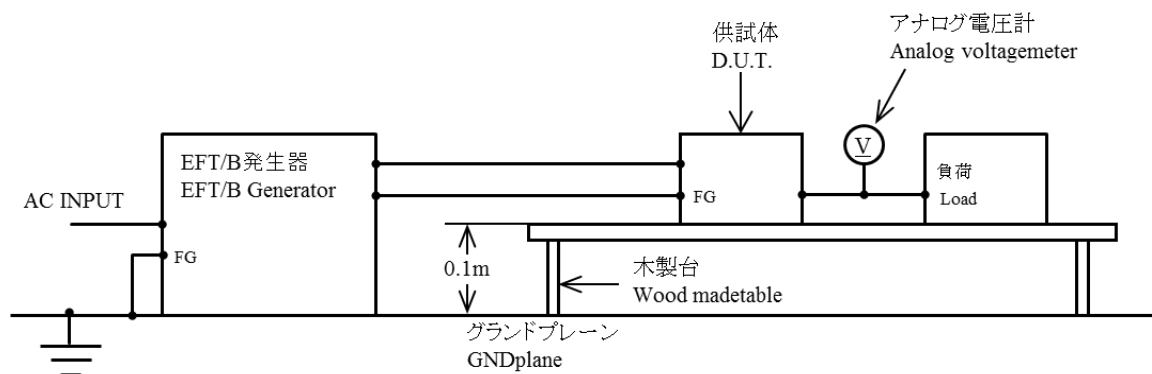

4.判定条件 Acceptable conditions

- ・試験中の出力電圧変動は、初期値(試験前)の±5%を超えないこと。
Output voltage regulation must not exceed ±5% of initial (before test) value during test.
- ・試験後の出力電圧は、初期値(試験前)から仕様範囲内の変動であること。
Output voltage after test shall be stable at the initial (before test) value (within specification range).
- ・試験中、発煙／発火及び出力低下が無いこと。
No discharge of fire or smoke, as well as no output failure during test.

5.試験結果 Test result

LEVEL	Test Voltage (kV)	Result
1	0.5	OK
2	1.0	OK
3	2.0	OK

MODEL | **LFS150A**サージ免疫試験
Surge Immunity Test(EN61000-4-5)

1.使用試験装置 Equipment used

- ・サージ発生器 Surge generator

2.試験条件 Test conditions

- ・カバー付き with Cover
- ・周囲温度 Ambient temperature : 25 °C
- ・入力電圧 Input voltage : 100 , 230 VAC
- ・出力電圧 Output voltage : 定格 Rated
- ・出力電流 Output current : 100 %
- ・試験回数 Number of tests : 5 times
- ・極性 Polarity : + , -
- ・位相 Phase : 0 , 90 , 270 deg
- ・モード Mode : コモン , ノーマル (Common , Normal)

3.試験方法及び印加箇所 Test method and Device test points

コモンモード(L-FG , N-FG)及びノーマルモード(L-N)に印加
Apply to Common mode(L-FG , N-FG) and Normal mode(L-N).

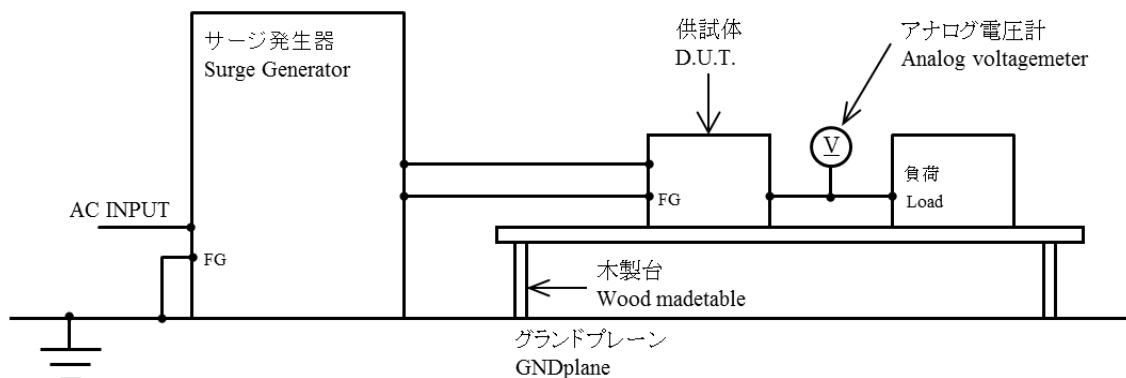

4.判定条件 Acceptable conditions

- ・試験中の出力電圧変動は、初期値(試験前)の±5%を超えないこと。
Output voltage regulation must not exceed ±5% of initial (before test) value during test.
- ・試験後の出力電圧は、初期値(試験前)から仕様範囲内の変動であること。
Output voltage after test shall be stable at the initial (before test) value (within specification range).
- ・試験中、発煙／発火及び出力低下が無いこと。
No discharge of fire or smoke, as well as no output failure during test.

5.試験結果 Test result

LEVEL	Test Voltage (kV)	Result		
		L-FG	N-FG	L-N
1	0.5	OK	OK	OK
2	1.0	OK	OK	OK
3	2.0	OK	OK	

MODEL LFS150A

伝導性無線周波数電磁界イミュニティ試験

Immunity to conducted disturbances, induced by radio-frequency fields (EN61000-4-6)

1. 使用試験装置 Equipment used

- ・RFパワーアンプ RF POWER AMPLIFIER
- ・シグナルジェネレータ SIGNAL GENERATOR
- ・結合／減結合ネットワーク(CDN) COUPLING DE-COUPLING NETWORK(CDN)

2. 試験条件 Test conditions

- ・カバー付き with Cover
- ・周囲温度 Ambient temperature : 25 °C
- ・入力電圧 Input voltage : 100, 230 VAC
- ・出力電圧 Output voltage : 定格 Rated
- ・出力電流 Output current : 100 %
- ・スイープ・コンディション Sweep condition : 1.0 %ステップ, 1.0 秒保持
1.0 %step up, 1.0 s hold
- ・電磁界周波数 Electromagnetic frequency : 150 kHz～80 MHz

3. 試験方法 Test method

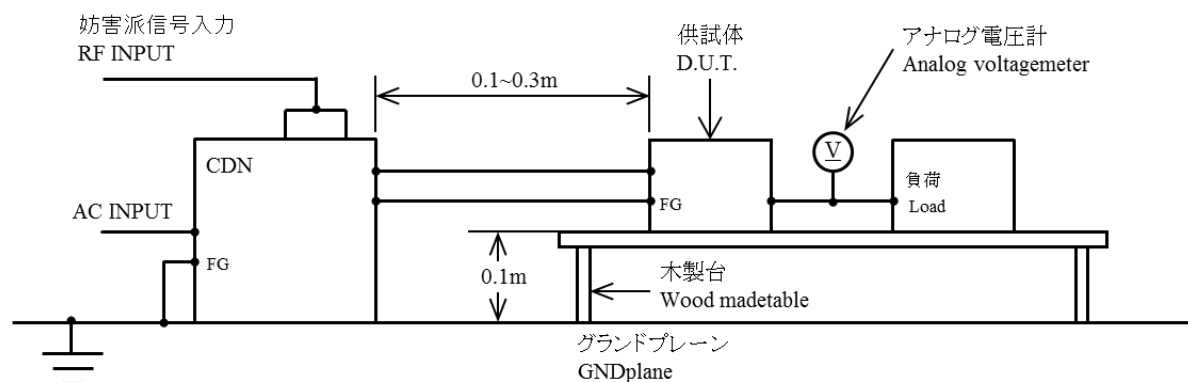

4. 判定条件 Acceptable conditions

- ・試験中の出力電圧変動は、初期値(試験前)の±5%を超えないこと。
Output voltage regulation must not exceed ±5% of initial (before test) value during test.
- ・試験後の出力電圧は、初期値(試験前)から仕様範囲内の変動であること。
Output voltage after test shall be stable at the initial (before test) value (within specification range).
- ・試験中、発煙／発火及び出力低下が無いこと。
No discharge of fire or smoke, as well as no output failure during test.

5. 試験結果 Test result

LEVEL	Voltage Level (V)	Result
1	1	OK
2	3	OK
3	10	OK

MODEL LFS150A

電力周波数磁界イミュニティ試験

Power Supply-Frequency Magnetic Field Immunity Test (EN61000-4-8)

1. 使用試験装置 Equipment used

- 電源周波数磁界試験装置 Power supply-frequency magnetic field testing machine

2. 試験条件 Test conditions

- カバー付き with Cover
- 周囲温度 Ambient temperature : 25 °C
- 入力電圧 Input voltage : 100, 230 VAC
- 出力電圧 Output voltage : 定格 Rated
- 出力電流 Output current : 100 %
- 印加方向 Direction : X, Y, Z
- 印加磁界周波数 : 50, 60 Hz
- Input magnetic frequency
- 試験時間 Test time : 1 min(各方向/Each direction)

3. 試験方法 Test method

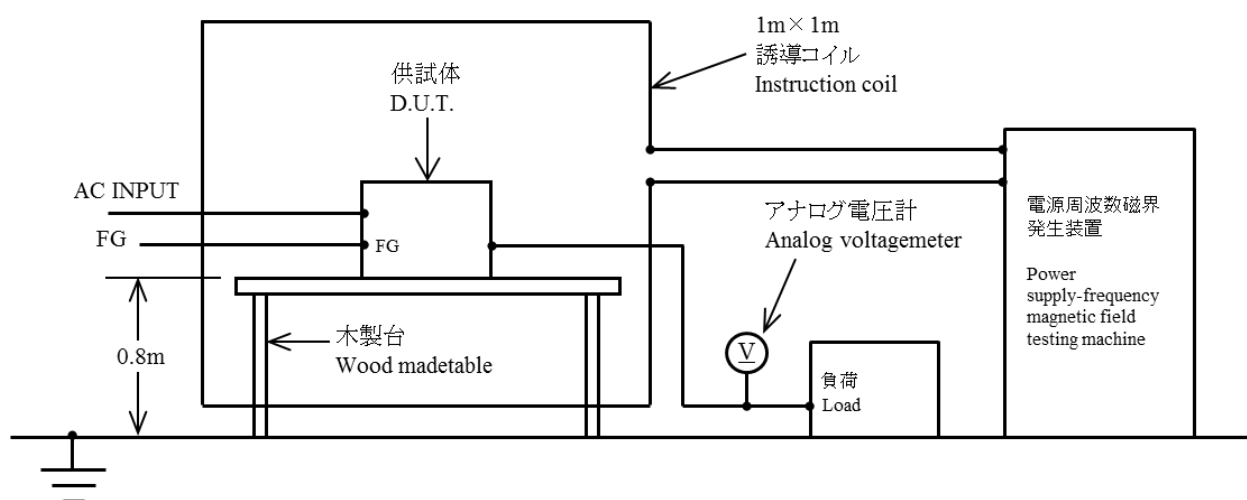

4. 判定条件 Acceptable conditions

- 試験中の出力電圧変動は、初期値(試験前)の±5%を超えないこと。
Output voltage regulation must not exceed ±5% of initial (before test) value during test.
- 試験後の出力電圧は、初期値(試験前)から仕様範囲内の変動であること。
Output voltage after test shall be stable at the initial (before test) value (within specification range).
- 試験中、発煙／発火及び出力低下が無いこと。
No discharge of fire or smoke, as well as no output failure during test.

5. 試験結果 Test result

LEVEL	Magnetic Field Strength (A/m)	Result
1	1	OK
2	3	OK
3	10	OK
4	30	OK

MODEL LFS150A-12

振動試験 Vibration Test

1. 使用試験装置 Equipment used

- ・ 振動試験装置 Vibration testing machine

2. 試験条件 Test conditions

- ・ 非動作 No operating.
- ・ 周囲温度 Ambient temperature : 25°C
- ・ 周波数範囲 Sweep frequency : 10-55Hz
- ・ 掃印時間 Sweep time : 1分間 1min.
- ・ 振動方向 Direction : X, Y, Z
- ・ 試験時間 Test time : 各方向60分間 60 min. each
- ・ 加速度 Acceleration : 19.6m/s² 一定

3. 試験方法 Test method

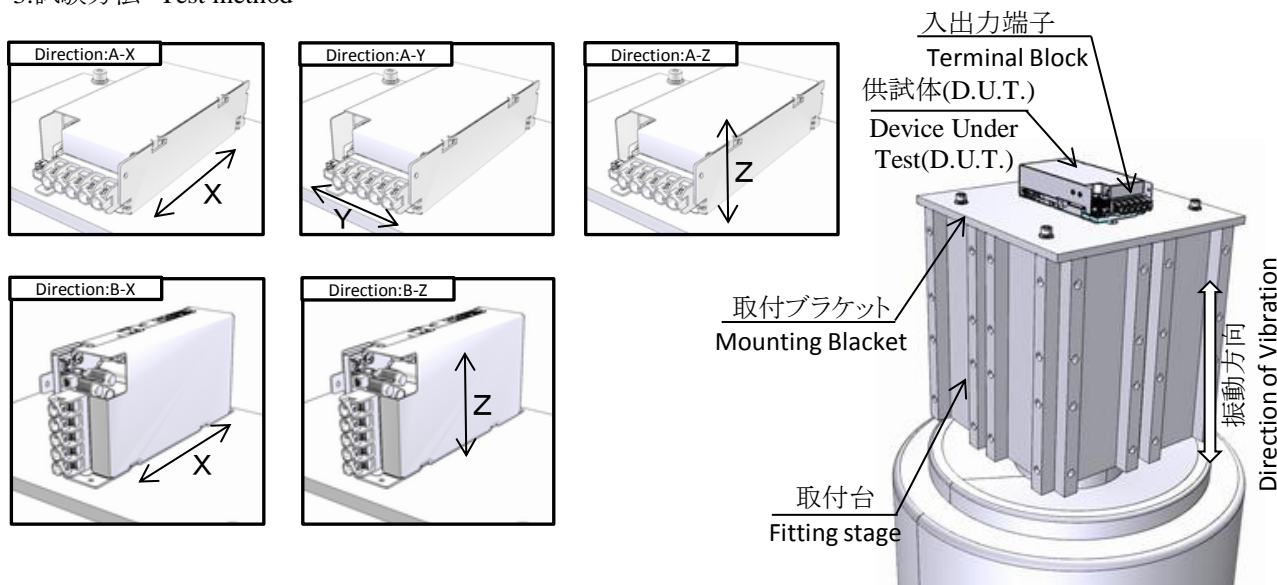

4. 試験結果 Test result

- ・ 確認条件 Check condition : 周囲温度 Ambient temperature 22 °C
- : 入力電圧 Input voltage 100 VAC
- : 出力電流 Output current 100 %

確認項目 Check item	出力電圧 Output voltage	出力リップルノイズ Output ripple noise	外観状態 State of appearance
試験前 Before test	12.01 V	8.0 mVp-p	異常無し OK
試験後 After test	12.01 V	6.9 mVp-p	異常無し OK

MODEL LFS150A-12

衝撃試験 Impact Test

1.使用試験装置 Equipment used

- ・振動試験装置 Vibration testing machine

2.試験条件 Test conditions

- ・カバー付き with Cover
- ・非動作 No operating.
- ・周囲温度 Ambient temperature : 25 °C
- ・パルス波形 Pulse waveform : 正弦半波 Half-sine waveform
- ・ピーク加速度 Peak acceleration : 300 m/s²
- ・衝撃方向 Direction : X, Y, Z
- ・試験時間 Test time : 11 ms X, Y, Z方向 各1回
11 ms, once each X, Y and Z axis 1times

3.試験方法 Test method

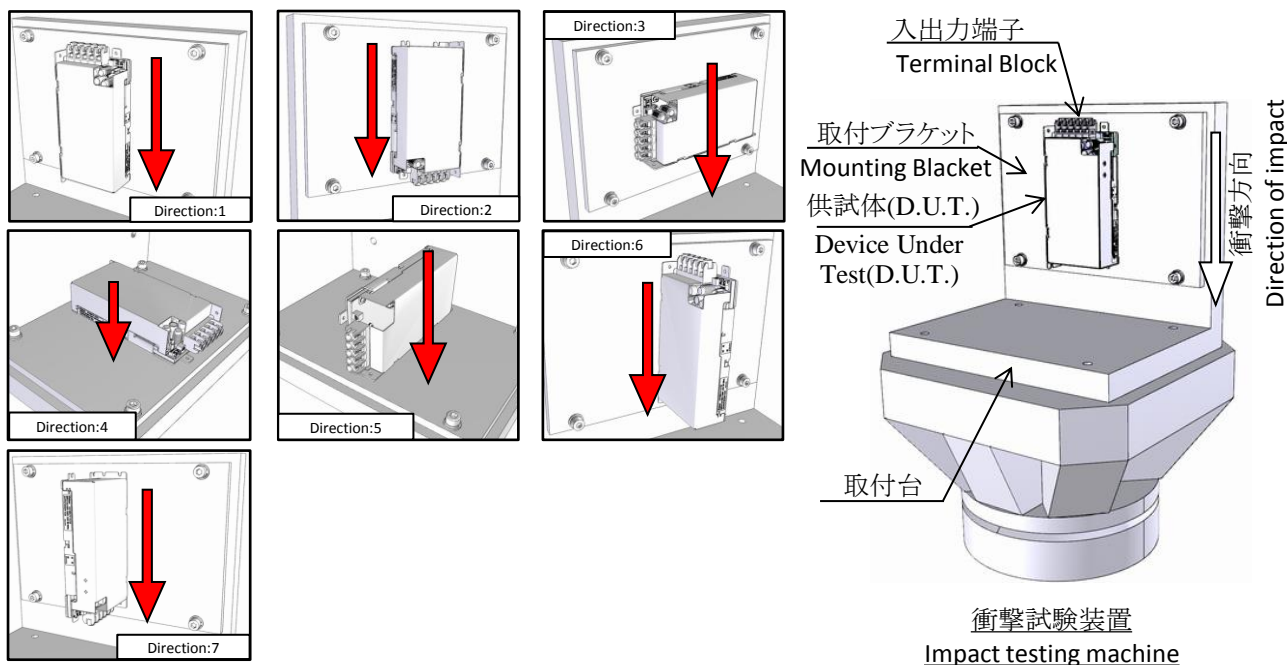

4.試験結果 Test result

- ・確認条件 Check condition : 周囲温度 Ambient temperature 22 °C
- : 入力電圧 Input voltage 100 VAC
- : 出力電流 Output current 100 %

確認項目 Check item	出力電圧 Output voltage	出力リップルノイズ Output ripple noise	外観状態 State of appearance
試験前 Before test	12.01 V	7.5 mVp-p	異常無し OK
試験後 After test	12.02 V	6.6 mVp-p	異常無し OK

Calculated values of MTBF

JEITA RCR-9102B

1. 算出方法 Part count reliability projection

MIL-HDBK-217F NOTICE 2の部品点数信頼度予測法により算出されています。

Calculated based on part count reliability projection of MIL-HDBK-217F NOTICE 2.

<算出式>

$$\lambda_{equip} = \sum_{i=1}^{i=n} N_i (\lambda_g \pi_q)_i \quad \text{式を簡単にする為に品質ファクタ } \pi_q = 1 \text{ とする。}$$

$$MTBF = \frac{1}{\lambda_{equip}} \times 10^6 = \frac{1}{\sum_{i=1}^{i=n} N_i (\lambda_g)_i} \times 10^6 \text{ [時間] [hour]}$$

λ_{equip} : 全機器故障率 (故障率/10⁶時間)
Total Equipment Failure Rate.(Failure/10⁶ hour)

λ_g : i番目の同属部品に対する故障率 (故障率/10⁶時間)
Generic Failure Rate for The ith Generic Part.

π_q : i番目の同属部品に対する品質ファクタ
Generic Quality Factor for The ith Generic Part.

N_i : i番目の同属部品個数
Quantity of ith Generic Part.

n : 異なった同属部品のカテゴリの数
Number of Different Generic Part Categories.

2. MTBF 値

 G_F : 地上・固定 (Ground, Fixed)

$$MTBF = 1 \times 10^6 / 5.516 = \frac{181,304 \text{ 時間}}{\text{hour}} = \frac{20.7 \text{ 年}}{\text{year}}$$